

For standby power supplies
 Expected trickle life: 6 years at 25°C
 10 years at 20°C

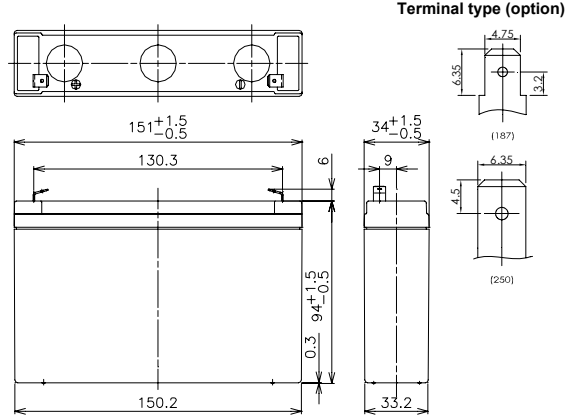

※Contents indicated (including the recycle marking, etc) are subject to change without notice.

■Dimensions(mm)



Battery case resin: Flame-retardant (UL94V-0)

■Specifications

Nominal Voltage		6V
Rated Capacity(cell@10MR)		45W
Dimensions	Length	151 mm
	Width	34 mm
	Height	94 mm
	Total height	100 mm
Approx. Mass		1.30 kg
Terminal		Faston 187 & 250

■Characteristics

Capacity (25 °C)	30 minute rate	56W
	15 minute rate	97W
	10 minute rate	135W
	5 minute rate	205W
Internal Resistance (25 °C)	Fully charged battery	10 mΩ
Temperature Dependency of Capacity (20 hour rate)	40 °C	102%
	25 °C	100%
	0 °C	85%
	-15 °C	65%
Self Discharge (25 °C)	After 3 months	91%
	After 6 months	82%
	After 12 months	64%

■Duration of discharge vs. discharge current

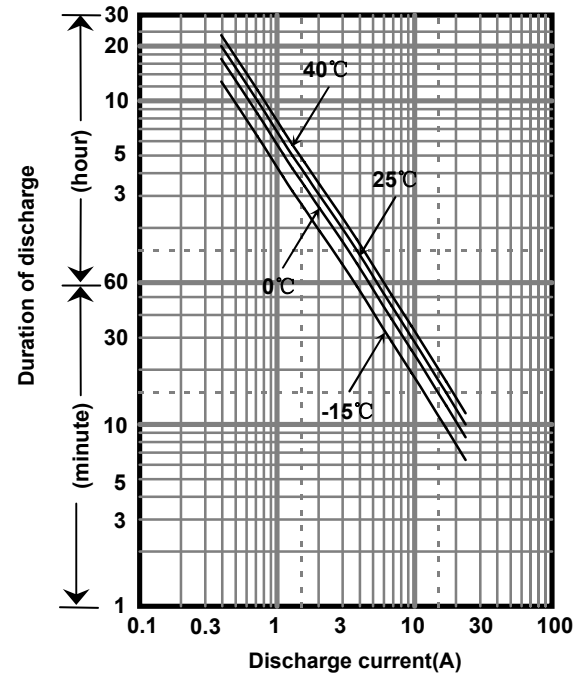

■Watt Table(25°C)

(Wattage/Battery)

Cut-off V	3min	5min	10min	15min	20min	30min	45min	1h	1.5h	2h	3h	4h	5h	6h	10h	20h
4.80V	265	205	135	97.5	79.5	56.0	41.1	32.8	22.6	17.5	13.0	9.99	8.25	6.63	4.39	2.38
4.95V	254	200	131	97.2	78.9	55.9	40.8	32.5	22.1	17.3	12.9	9.92	8.18	6.60	4.37	2.37
5.10V	245	195	129	96.5	78.0	55.5	40.4	32.2	21.7	16.9	12.8	9.86	8.12	6.55	4.33	2.37
5.25V	231	180	123	93.4	75.4	55.0	39.3	31.5	20.8	16.4	12.6	9.85	8.07	6.48	4.31	2.36
5.40V	217	165	117	90.0	73.0	54.5	39.1	30.9	20.6	15.5	12.4	9.66	7.85	6.37	4.26	2.35

■Ampere Table(25°C)

(Ampere/Battery)

Cut-off V	3min	5min	10min	15min	20min	30min	45min	1h	1.5h	2h	3h	4h	5h	6h	10h	20h
4.80V	47.7	36.8	23.9	17.0	13.7	9.57	6.99	5.57	3.82	2.95	2.19	1.67	1.38	1.11	0.732	0.397
4.95V	45.8	35.9	23.5	16.9	13.6	9.55	6.95	5.50	3.75	2.93	2.17	1.66	1.37	1.10	0.729	0.396
5.10V	44.1	35.0	23.0	16.8	13.5	9.49	6.88	5.46	3.67	2.86	2.15	1.65	1.36	1.09	0.721	0.394
5.25V	41.6	32.3	22.0	16.3	13.0	9.40	6.70	5.35	3.53	2.77	2.11	1.64	1.35	1.08	0.718	0.393
5.40V	39.0	29.6	20.9	15.7	12.6	9.32	6.67	5.25	3.50	2.62	2.08	1.62	1.31	1.06	0.710	0.391

All mentioned values are average values

Charging Method (25°C)

Trickle use	Control voltage: 6.80-6.90V Initial current: 1.20A or smaller
-------------	--

Cut off voltage

Discharge current	0.400A-1.60A	1.60A-4.00A	4.00A-8.00A	8.00A-16.0A	16.0A-24.0A
Cut off voltage(V)	5.25	5.10	4.95	4.65	4.35

Influence of Temperature on Trickle life

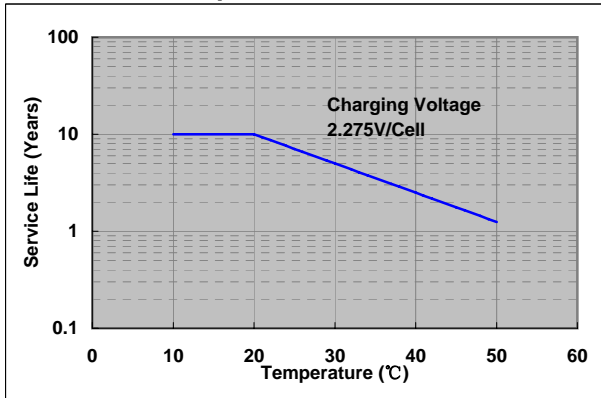

Residual capacity test result

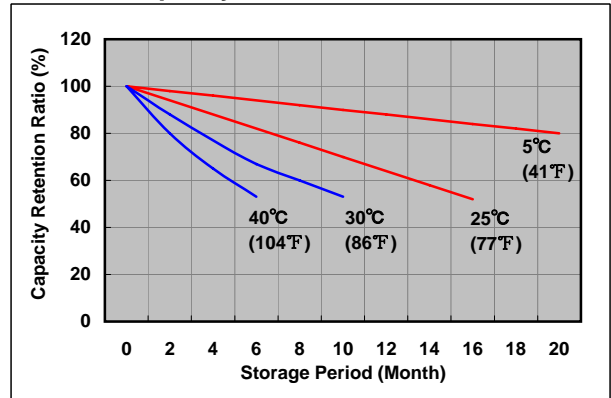

Constant-voltage constant-current charge characteristics for Trickle use

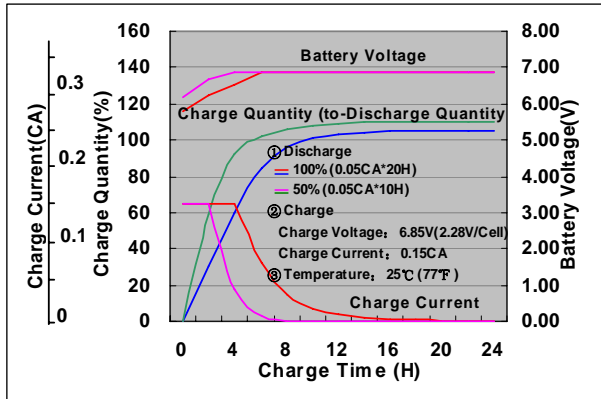

Discharge capacity by temperature and by discharge current

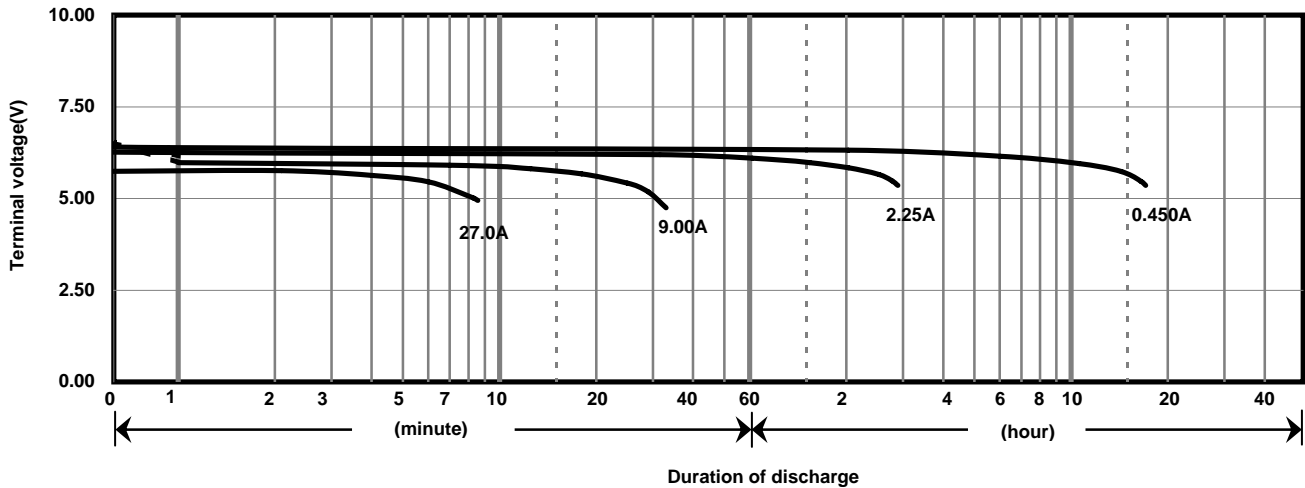
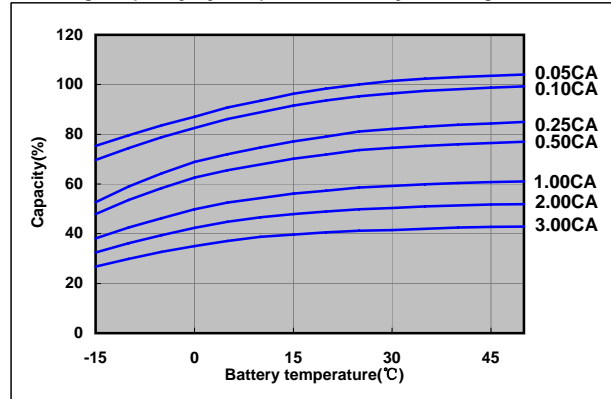

Caution

Due to the potential energy stored in the batteries, Please read 《Precautions for handling the Rechargeable Valve Regulated Lead Acid Batteries》 before using batteries. If improper handling or use of the batteries without understanding 《Precautions for handling the Rechargeable Valve Regulated Lead Acid Batteries》 may result in bodily injury caused by electrolyte leakage, heat generation, or explosion.

Panasonic Storage Battery (Shenyang) Co., Ltd

NO. 17 Hunhe 20Th Street, Shenyang Economic & Technical Development Zone, 110142 China

Tel: 86 24 25818921

Fax: 86 24 62786318

Website: <http://www.panasonicbattery.cn>

2015.01