

For pitch backup systems in wind turbines
 Expected life: 5 years at 20 °C, 3 years at 25 °C
 (based on a weekly discharge cycle of max 15 seconds)

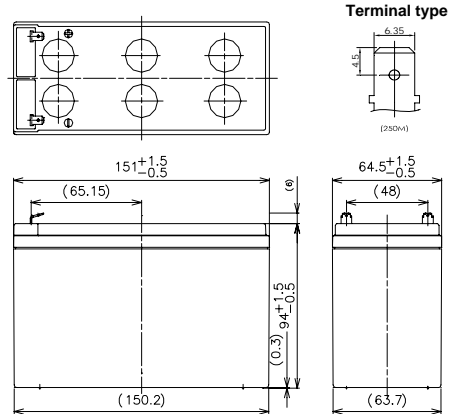

Contents indicated (including the recycle marking, etc) are subject to change without notice.

Dimensions(mm)



Battery case resin: Flame-retardant (UL94V-0)

Specifications

Nominal Voltage	12V	
Rated Capacity(20HR)	7.2Ah	
Dimensions	Length	151 mm
	Width	64.5 mm
	Height	94 mm
	Total height	101.5 mm
Approx. Mass	2.50 kg	
Terminal	Faston 250M	

Characteristics

Capacity (25 °C)	20 hour rate	7.2Ah
	10 hour rate	6.5Ah
	3 hour rate	5.8Ah
	1 hour rate	4.9Ah
Internal Resistance (25 °C)	Fully charged battery	21 m
Temperature Dependency of Capacity (20 hour rate)	40	102%
	25	100%
	0	85%
	-15	65%
Self Discharge (25 °C)	After 3 months	91%
	After 6 months	82%
	After 12 months	64%

Duration of discharge vs. discharge current

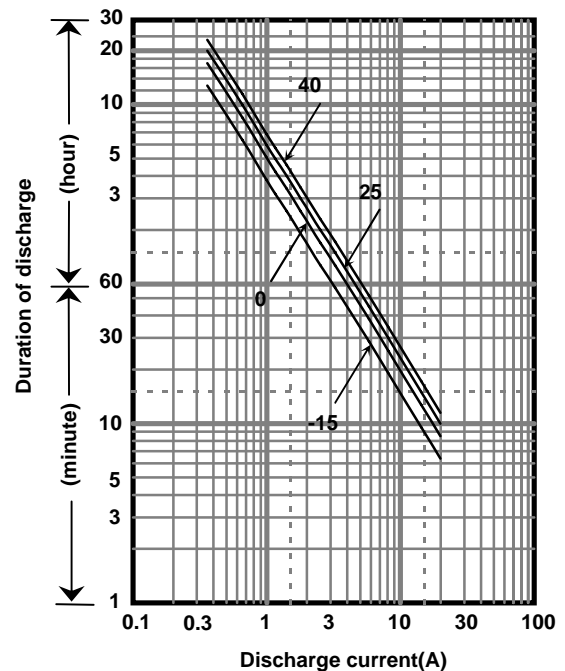

Large current discharge characteristics(25 °C)

Peak current(A for milliseconds)	160	150	140	130	120	112	105	94	86	80	75
Discharge current(A)	144	135	126	117	108	101	95	85	78	72	68
Discharge time(sec)	3	6	10	15	20	25	30	40	50	60	70

Peak current(A for milliseconds)	70	66	62	59	55	52	49	46	44	42	40
Discharge current(A)	63	60	56	53	50	47	44	42	40	38	36
Discharge time(sec)	80	90	100	110	120	130	140	150	160	170	180

The cut off voltage should be more than 8.0V. Battery should be charged after each discharge. All mentioned values are average values.

Charging method

**Control voltage: 13.6V~13.8V at 20 ~25 °C with temperature compensation, Initial current: 1.08A or smaller

**Please consult us for the right control voltage if the ambient temperature is different.

Operating temperature range

*Storage	Charge	Discharge
-40 ~ 50	-20 ~ 50	-20 ~ 50

* For storage, please ensure that battery is fully charged.

Influence of Temperature on Trickle life

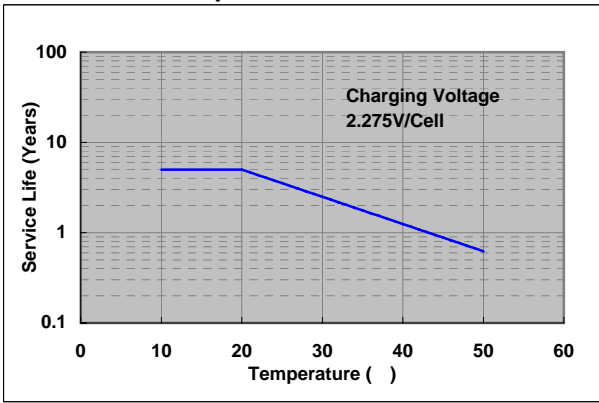

Residual capacity test result

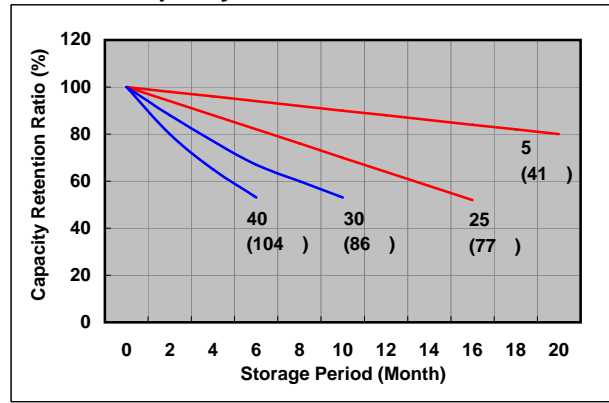

Constant-voltage constant-current charge characteristics for Trickle use

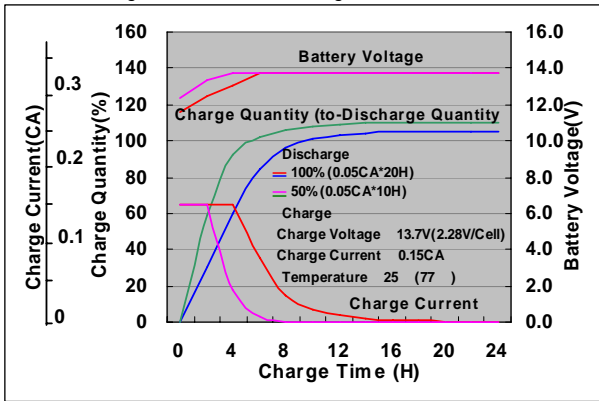

Discharge capacity by temperature and by discharge current

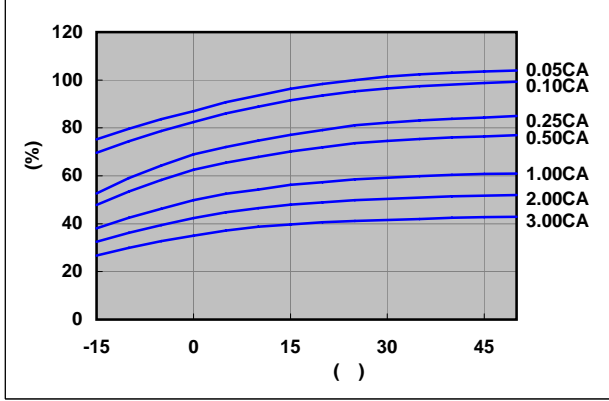

Discharge characteristics(25 °C)

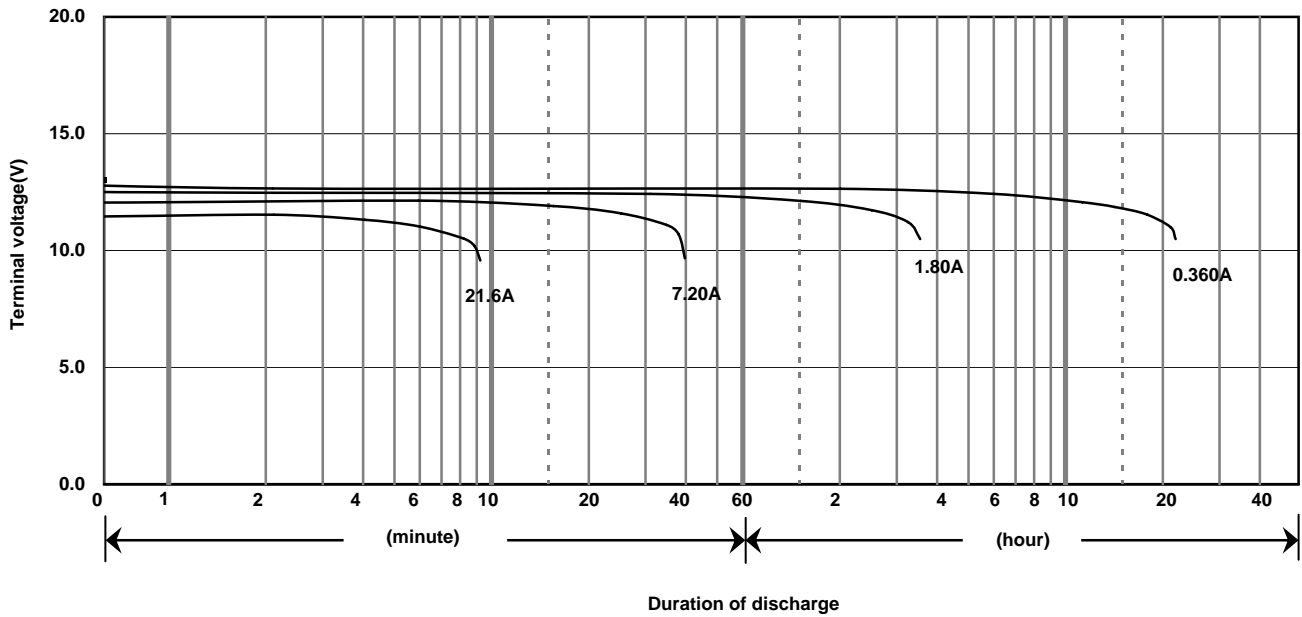

Caution

Due to the potential energy stored in the batteries, Please read Precautions for handling the Rechargeable Valve Regulated Lead Acid Batteries before using batteries. If improper handling or use of the batteries without understanding Precautions for handl

Panasonic Storage Battery (Shenyang) Co., Ltd

NO. 17 Hunhe 20Th Street, Shenyang Economic & Technical Development Zone,110142 China
 Tel: 86 24 25818921
 Fax: 86 24 62786318
 Website: <http://www.panasonicbattery.cn>

2015.01